









Tracks/ profiles	Colour	Length - 170 cm	Length - 235 cm	Length - 270 cm	Length - 300 cm	Length - 405 cm	Length - 600 cm
Handle NOVO S	aluminium	-	-	A-R18NOVS-270-05	-	-	-
	champagne	-	-	A-R18NOVS-270-90	-	-	-
	white	-	-	A-R18NOVS-270-10	-	-	-
Top track	aluminium	A-TG-170-05	A-TG-235-05	-	A-TG-300-05	A-TG-405-05	A-TG-600-05
	champagne	A-TG-170-90	A-TG-235-90	-	A-TG-300-90	A-TG-405-90	A-TG-600-90
	white	-	-	-	A-TG-300-10	-	-
Top strip 18/4 mm	aluminium	A-LG18-170-05	A-LG18-235-05	-	A-LG18-300-05	A-LG18-405-05	A-LG18-600-05
	champagne	A-LG18-170-90	A-LG18-235-90	-	A-LG18-300-90	A-LG18-405-90	A-LG18-600-90
	white	-	-	-	A-LG18-300-10	-	-
HR-profile 18/4 mm	aluminium	-	-	-	A-HR18-300-05	-	-
	champagne	-	-	-	A-HR18-300-90	-	-
	white	-	-	-	A-HR18-300-10	-	-
HRS-profile 18/4 mm	aluminium	A-HRS18-170-05	A-HRS18-235-05	-	A-HRS18-300-05	A-HRS18-405-05	A-HRS18-600-05
	champagne	A-HRS18-170-90	A-HRS18-235-90	-	A-HRS18-300-90	A-HRS18-405-90	A-HRS18-600-90
	white	-	-	-	A-HRS18-300-10	-	-
Bottom strip 18/4 mm	aluminium	A-LD18-170-05	A-LD18-235-05	-	A-LD18-300-05	A-LD18-405-05	A-LD18-600-05
	champagne	A-LD18-170-90	A-LD18-235-90	-	A-LD18-300-90	A-LD18-405-90	A-LD18-600-90
	white	-	-	-	A-LD18-300-10	-	-
Bottom track PRO	aluminium	A-TDPRO-170-05	A-TDPRO-235-05	-	A-TDPRO-300-05	A-TDPRO-405-05	A-TDPRO-600-05
	champagne	A-TDPRO-170-90	A-TDPRO-235-90	-	A-TDPRO-300-90	A-TDPRO-405-90	A-TDPRO-600-90
Masking cover PRO	aluminium	A-MPRO-170-05	A-MPRO-235-05	-	A-MPRO-300-05	A-MPRO-405-05	-
	champagne	A-MPRO-170-90	A-MPRO-235-90	-	A-MPRO-300-90	A-MPRO-405-90	-
Bottom track EVO	aluminium	A-TDEVO-170-05	A-TDEVO-235-05	-	A-TDEVO-300-05	A-TDEVO-405-05	A-TDEVO-600-05
	champagne	A-TDEVO-170-90	A-TDEVO-235-90	-	A-TDEVO-300-90	A-TDEVO-405-90	A-TDEVO-600-90
	white	-	-	-	A-TDEVO-300-10	-	-
Masking cover EVO	aluminium	A-MEVO-170-05	A-MEVO-235-05	-	A-MEVO-300-05	A-MEVO-405-05	-
	champagne	A-MEVO-170-90	A-MEVO-235-90	-	A-MEVO-300-90	A-MEVO-405-90	-
	white	-	-	-	A-MEVO-300-10	-	-

Complementary elements	Top roller 18 mm	Bottom roller PRO - frame	Bottom roller EVO - frame	Top positioner	Bottom positioner	Buffer strip 14,5x4	Anti-dust strip without glue 4,8x12	Wedge for handle	Wedge for horizontal strips	Steel metal screw 6,3x40
		 A-PGR-18	 A-WDR-PRO	 A-WDR-EVO	 A-PTG	 A-PTD	 A-SO-145X4	 A-SP-48X12	 A-KR-4	 A-KLP-4

Dimensions of door

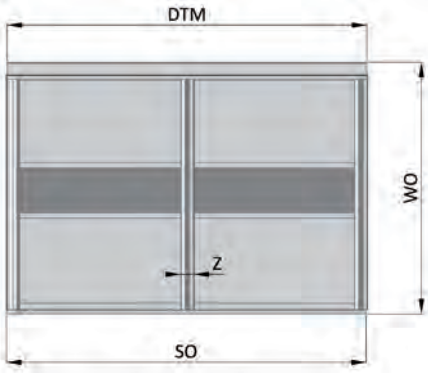

Door dimensions



Dimensions of fillings and profiles

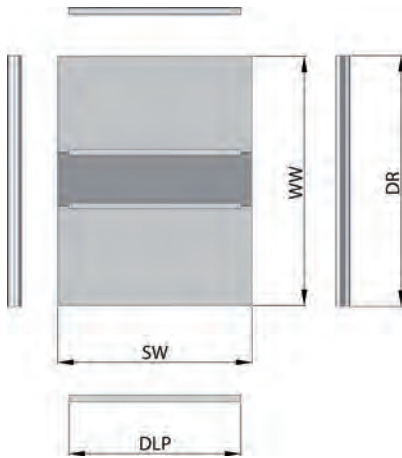

Number of doors $n = 2$,
number of overlaps $k = 1$



Number of doors $n = 3$,
number of overlaps $k = 2$

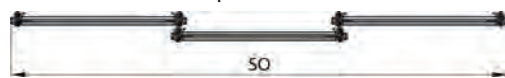

In case of a facade with four doors in a symmetrical arrangement (number of doors $n = 4$, number of overlaps $k = 2$), the calculations should be made according to: values $n = 2$ and $k = 1$ and the opening width, equal to half the real width.



DESIGNATIONS

- SO - opening width
- WO - opening height
- DTM - Length of tracks and covers (fascia panels)
- SD - door width
- WD - door height
- k - number of overlaps
- Z - overlap width, $Z = 34$ mm
- n - number of doors
- SW - width of filling
- WW - height of filling
- DLP - Length of horizontal strips
- DR - Length of handles

Length of lower and upper track and cover

$DTM = SO$

DOOR DIMENSIONS

Door height

$WD = WO - 40$

Width calculation for door with buffer strip					
Overlap width	Z = 34 mm				General formula
Number of doors	n = 2	n = 3	n = 4		$SD = \frac{(SO - 3 + k * Z)}{n}$
Number of overlaps	k = 1	k = 2	k = 2	k = 3	
Simplified formula	$SD = \frac{(SO + 31)}{2}$	$SD = \frac{(SO + 65)}{3}$	$SD = \frac{(SO + 65)}{4}$	$SD = \frac{(SO + 99)}{4}$	

Calculations for door width with buffer strip					
Overlap width	Z = 34 mm				General formula
Number of doors	n = 2	n = 3	n = 4		$SD = \frac{(SO + k * Z)}{n}$
Number of overlaps	k = 1	k = 2	k = 2	k = 3	
Simplified formula	$SD = \frac{(SO + 34)}{2}$	$SD = \frac{(SO + 68)}{3}$	$SD = \frac{(SO + 68)}{4}$	$SD = \frac{(SO + 102)}{4}$	

FILLING DIMENSIONS

Width of filling #18

$SW_{18} = SD - 36$

Height of filling #18

$WW_{18} = WD - 69$

Width of pane filling #4 mm

$SW_4 = SD - 24$

Height of pane filling #4 mm

$WW_4 = WD - 61$

When using joined fillings, take the H-profiles dimensions into account. The total clearance for pane fillings equal to 1 - 2 mm should be assumed. The clearance for panel fillings of up to 2 mm is taken into consideration in the calculations.

LENGTHS OF ALUMINIUM PROFILES

Length of horizontal strips

$DLP = SD - 52$

Length of handles

$DR = WD$

STRIP LENGTHS

Buffer strip length

$Dso = WD$

Anti-dust strip length

$Dsp = WD - 30$

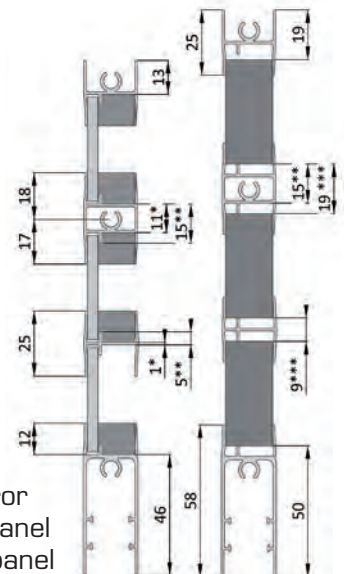

for mirror / mirror
 ** for mirror / panel
 *** for panel / panel

INSTALLATION OF DOOR

Distance between wedges max. 30 cm.

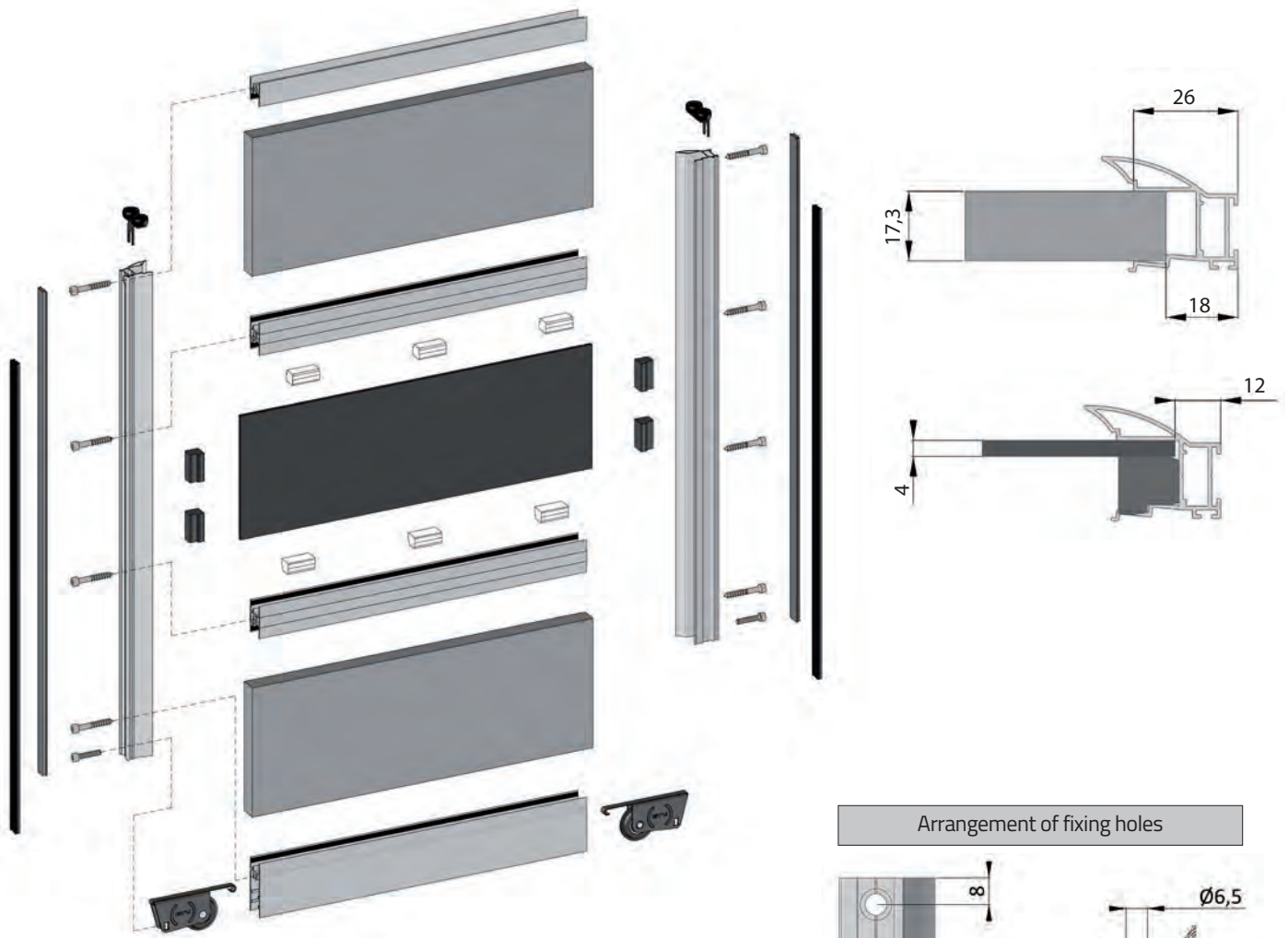

Arrangement of fixing holes

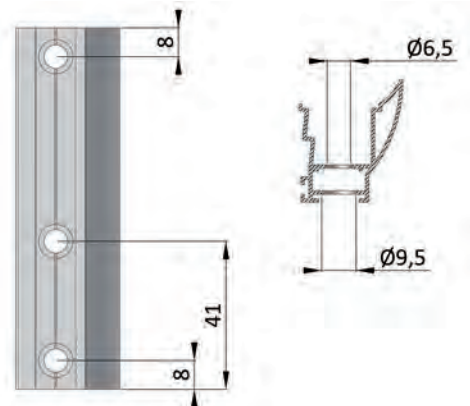

The steel metal screws 6.3x40 (for fixing the handle to the bottom strip) are delivered with the sets of the bottom rollers (2 pieces). The other parts of the frame should be fastened with the screws 6.3x40. Index: A-B63-40

INSTALLATION OF BOTTOM TRACKS

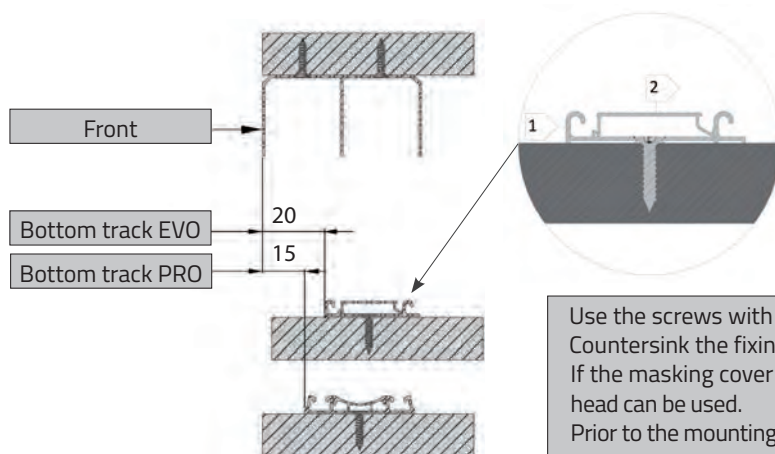

1. Pay attention to the correct direction of the installation of tracks.
2. Pay attention to the correct direction and attachment of cover.

Use the screws with tapered head for the installation of tracks. Countersink the fixing holes. If the masking cover for the bottom track is applied, the screws with flat head can be used. Prior to the mounting of the bottom track PRO, mount the bottom positioner.

INSTALLATION OF POSITIONER IN TOP TRACK OR IN BOTTOM TRACK

For the lower track **EVO** – mount always the top positioner.

For the lower track **PRO** – mount the top positioner or the bottom positioner.



INSTALLATION OF DOOR

Make sure that the tracks are installed properly prior to the attachment of the cover.
Attach the cover prior to the installation of door.

